

GP-7T Pneumatic grip

- Clamping force: 7 kN /7bar (max.20bar)
- Standard temperature range: 0 °C - +70°C
with Viton: -70°C - +180°C
Further temperature ranges on request
- Body made of aluminum
- Pneumatic internal thread connection: 1/8"
- Weight 3.2 kg each without jaws
- Scope of supply: 1 pair

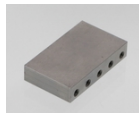

Jaws for GP-7T: Scope of supply: 1 Set = 4 jaws



- Blank (smooth) jaws**
- Suitable for own further treatments
 - Steel-blanks without coating

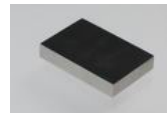

- Rubber coated jaws**
- 1 mm rubber coating (NBR)
 - Nickel-plated

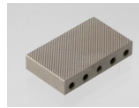

- Pyramid jaws (serrated)**
- Pyramids 1.2x45
 - Hardened steel 58HRC
 - Nickel-plated°

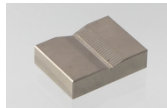

- V-jaws**
- For all kinds of round samples
 - Tooth pitch 1.2 mm
 - Hardened steel 58HRC
 - Nickel-plated



- Wave jaws (corrugated)**
- For flexible materials
 - Wave 5 mm
 - Hardened steel 58HRC
 - Nickel-plated

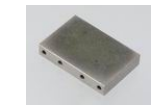

- Diamond coated jaws**
- Clamping surface coated with synthetic diamonds D91 (170/200 mesh)
 - Nickel-plated

Item number	Surface	Clamping surface H x W	Opening	Temperature range	Weight/ 1 pair
GP-7T-B	Blank jaws	40 x 60mm	0 – 10 mm*	+20 °C - +180°C	0.35 kg
GP-7T-BG	Rubber coated jaws	40 x 60mm	0 – 10 mm*	- 70 °C - +70°C	0.36 kg
GP-7T-BP	Pyramid jaws	40 x 60mm	0 – 10 mm*	- 70 °C - +180°C	0.33 kg
GP-7T-BV	V-jaws	clamping height 40mm	4 – 12 mm Ø**	- 70 °C - +180°C	0.32 kg
GP-7T-BW	Wave jaws	40 x 60mm	0 – 10 mm*	- 70 °C - +180°C	0.40 kg
GP-7T-BD	Diamond coated jaws	40 x 60mm	0 – 10 mm*	- 70 °C - +180°C	0.35 kg
GP-7T-B100	Blank jaws	40 x 100 mm	0 – 10 mm*	+20 °C - +180°C	0.72 kg
GP-7T-BG100	Rubber coated jaws	40 x 100 mm	0 – 10 mm*	- 70 °C - +70°C	0.74 kg
GP-7T-BP100	Pyramid jaws	40 x 100 mm	0 – 10 mm*	- 70 °C - +180°C	0.69 kg
GP-7T-BW100	Wave jaws	40 x 100 mm	0 – 10 mm*	- 70 °C - +180°C	0.66 kg
GP-7T-BD100	Diamond coated jaws	40 x 100 mm	0 – 10 mm*	- 70 °C - +180°C	0.72 kg
GP-7T-BW200	Wave jaws	60 x 200 mm	0 – 10 mm*	0 °C - +180°C	3.00 kg

* On request: opening 10mm – 20mm and 20mm – 30mm

** On request: for round samples 8-30mm Ø

Inset jaws for GP-7T:

Jaw quick changing system

Inset jaws require carriers (GP-7T-GT..)

Scope of delivery: 1 Set = 4 jaws

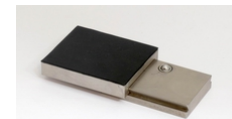

Item number	Surface	Clamping surface H x W	Opening*	Temperature range	Weight/ 1 pair
GP-7T-GT	Carrier	-	-	- 70 °C - +180°C	0.33 kg
GP-7T-EB	Blank inset jaws	50 x 60mm	0-9mm	+20 °C - +180°C	0.29 kg
GP-7T-EBG	Rubber coated inset jaws	50 x 60mm	0-9mm	- 70 °C - +70°C	0.30 kg
GP-7T-EBP	Pyramid inset jaws	50 x 60mm	0-9mm	- 70 °C - +180°C	0.28 kg
GP-7T-EBW	Wave inset jaws	50 x 60mm	0-9mm	- 70 °C - +180°C	0.26 kg
GP-7T-EBD	Diamond coated inset jaws	50 x 60mm	0-9mm	- 70 °C - +180°C	0.29 kg
GP-7T-GT100	Carrier	-	-	- 70 °C - +180°C	0.69 kg
GP-7T-EB100	Blank inset jaws	50 x 100mm	0-9mm	+20 °C - +180°C	0.63 kg
GP-7T-EBG100	Rubber coated inset jaws	50 x 100mm	0-9mm	- 70 °C - +70°C	0.65 kg
GP-7T-EBP100	Pyramid inset jaws	50 x 100mm	0-9mm	- 70 °C - +180°C	0.60 kg
GP-7T-EBW100	Wave inset jaws	50 x 100mm	0-9mm	- 70 °C - +180°C	0.57 kg
GP-7T-EBD100	Diamond coated inset jaws	50 x 100mm	0-9mm	- 70 °C - +180°C	0.63 kg

* On request: opening 9–19mm

Jaws with other dimensions and surface coatings on request

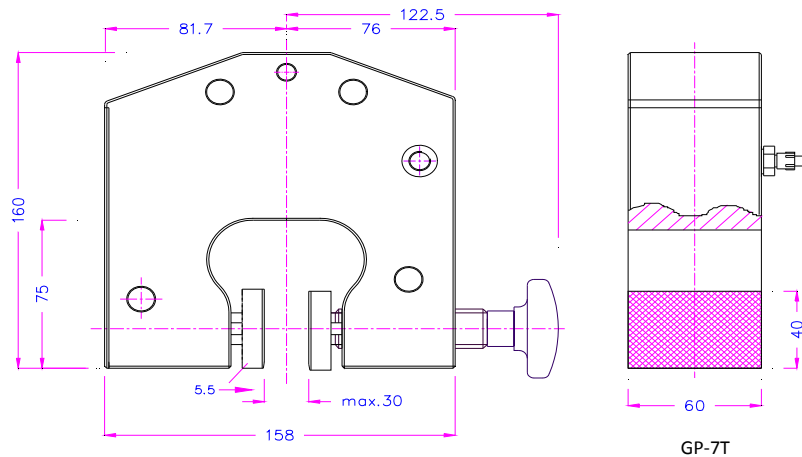

GP-7T + GP-7T-BW200



GP-7T + GP-7T-GT100 + GP-7T-EBG100

Accessories:



TH205-1

2 pneumatic foot switches, tubes and fittings

None locking: The jaws of the grip open by pressing the foot pedal and close after removing the foot from the pedal.

Scope of delivery: 1 pair of foot switches including tubes and fittings



TH205-2

2 pneumatic foot switches, tubes and fittings,

With locking function: The jaws of the grip open by pressing the foot pedal and remain opened after removing the foot from the pedal. The jaws close by pressing the pedal one more time.

Scope of delivery: 1 pair of foot switches including tubes and fittings



TH205-+PR

Optional for TH205-1 or TH205-2

Pressure regulator

To adjust air pressure: 1-10 bar



TH205-3

1 unit of pneumatic hand switches, tubes and fittings

With locking function: Handle with 2 positions. The jaws of the grip close by pulling the handle and remain closed. The jaws open by pushing the handle back.

Scope of delivery: 1 unit of hand switches including tubes and fittings



TH205-4

Pneumatic Micro – hand switches, tubes and fittings

With locking function: The hand switches will be connected directly at the grips (only for 1/8" couplings), 3/2 directional valve

Scope of supply: 2 hand switches including tubes and fittings



TH216

Silent compressor appropriate for laboratories

Max pressure: 16 bar; noise level: 45dB(A)

Motor 400 Watt; displacement 25 l/min

With pressure reducer / water trap

Dimensions: 280x190x240 mm (L x W x H); weight ~ 14 kg